

# ADA360K120S001A

## 产品特点:

- 宽输入电压: 输入工作电压范围 100-240VAC。
- 低功耗: 空载损耗<0.075W。
- 高效能: 六级能耗, 功率效率 89%。
- 高可靠性: 符合 EN60601-1 CLASS II 安全等级和 2×MOPP 绝缘防护等级, 通过 CE 认证。
- 阻燃绝缘: UL94V-0 阻燃耐热材料。
- 保护种类: 短路保护、过流保护、过压保护, 并可自恢复。
- 便捷转换: 适配英规、澳规、欧规、美规、中规五款转换插头。

## Features:

- Wide input voltage: the input working voltage range is 100-240VAC.
- Low power consumption: No-load <0.075W.
- High Energy Efficiency: Six levels of energy consumption, power efficiency up to 89%.
- High reliability: Comply with EN60601-1 CLASS II safety level and 2×MOPP insulation protection level, and pass CE.
- Flame retardant insulation: UL94V-0 flame retardant heat resistant material.
- Protection types: short circuit protection, over current protection, over voltage protection, and self-recovery.
- Convenient conversion: Adapt to five conversion plugs of British, Australian, European, American, and Chinese.



## 1、产品介绍 Product Introduction

ADA360K120S001A 产品是一款单组输出的壁挂式电源适配器。采用 100-240VAC 全球通用输入电压，可持续输出 12VDC 直流电压。提供英规、澳规、欧规、美规、中规五款便捷转换插头选项，满足多种外接电源需求。广泛应用于血糖仪、血氧仪、COVID-19 核酸检测仪、家用美容仪器、理疗仪等便携式医疗设备。

ADM360K120S001A is a wall-mounted power adapter with a single output. With 100 -240 VAC universal input voltage, it can continuously output any DC voltage of 12VDC. Provides five portable conversion plug options for British, Australian, European, American, and Chinese regulations to meet a variety of external power requirements.widely used in portable medical equipment such as blood glucose meters, oximeters, COVID-19 nucleic acid detector, household medical cosmetology instrument, physiotherapy device, etc.

### 1.1 使用说明 Hardware and interface



## 1.2 型号列表 Selection

型号 Model	最大功率 Max. Power	输入电压 Input voltage	输出电压/电流 Voltage /Current	效率 Efficiency	最大容性负载 Max. Capacitive load	待机功耗 Standby Power Consumption
ADA360K120 S001A	36W	100-240 VAC	DC12V /3000mA	89%	5000uF	0.075W

## 1.3 命名规则 Naming Rules

序号 Serial	类别 Category	编号 Number	说明 Remark
1	产品编码 Product Code	AD	2 位字符: AD=隔离型 AC/DC DD=隔离型 DC/DC 2 characters: AD=Isolated AC/DC DD=Isolated DC/DC
2	封装形式 Packaging Form	M	1 位字符: A=适配器 M=树脂灌装模块 P=PCB 模块 1 character: A=adapter M=resin filling module P=PCB module
3	功率编码 Power Coding	350	3 位数字编码: 前两位数字,第 3 位是 10 的指数: 010=1W 100=10W 101=100W 350=35W 3-digit Code: The first two digits, the third is the index of 10: 010=1W 100=10W 101=100W 350=35W
4	应用级别 Application Level	K	C=商业级 T=工业级 K=医用级 S=苛刻环境应用 C=commercial T=industrial grade K=medical grade S=harsh environment application
5	输出电压 Output Voltage	120	3 位编码: 033=3.3V 050=5V 120=12V 240=24V 11A=110V 3-bit Code:033=3.3V 050=5V 120=12V 240=24V 11A=110V
6	定制标记 Custom Tag	S	S=标准品 Z=定制品 S=standard product Z=customized product
7	产品序列号 Product ID	3 位数字 3-digit number	001-999, 用于标识相同类别的不同产品 001-999, used to identify different products of the same category
8	重大升级信息 Major Upgrade Information	1 位字符 1 character	A-Z, 首次量产固定为 A A-Z, fixed as a for the first mass production
<p>举例: ADM350K135S001A 13.5V 35W 医用级树脂灌装 AC/DC 电源模块 example:Adm350k135s001a 13.5V 35W medical resin filling AC / DC power module</p>			

## 2、规格参数 Specification parameters

### 2.1 输入参数 Input Parameter

项目 Item	工作条件 Conditions	最小值 Min	典型值 Typ	最大值 Max	单位 Unit
输入电压范围 Input voltage range	交流输入 AC input	100	-	240	VAC
输入频率 Input frequency	-	50	-	60	Hz
输入电流 Input current	115VAC	-	-	0.7	A
	230VAC	-	-	0.5	
冲击电流 Impulse current	115VAC	-	10	-	
	230VAC	-	25	-	
漏电流 Leakage current	264VAC/60Hz	-	0.1	-	mA

### 2.2 输出参数 Output parameters

项目 Item	工作条件 conditions	最小值 Min	典型值 Typ	最大值 Max	单位 Unit
输出电压精度 Output voltage accuracy	-	-	±5	-	%
线性调节率 Linear regulation rate	满载 Full load	-	±0.5	-	
负载调节率 Load regulation rate	-	-	±1	-	
纹波噪声 Ripple noise	20MHz	-	50	100	mV
温度漂移系数 Temperature drift coefficient	-	-	±0.02	-	%/°C
短路保护 Short circuit protection	-	可长期短路, 自恢复 Long term short circuit, self recovery			
过流保护 Over current protection	-	≥130%IO 自恢复 ≥ 130% IO self recovery			
过压保护 Over voltage protection	12V 输出 12V output	≤27VDC			
	24V 输出 24V output	≤40VDC			

## 2.2 输出参数 Output parameters

项目 Item	工作条件 conditions	最小值 Min	典型值 Typ	最大值 Max	单位 Unit
待机功耗 standby power	-	-	-	0.075	W
最小负载 Minimum load	-	0	-	-	%
掉电保持时间 Power down hold time	115VAC 输入 115VAC input	-	15	-	ms
	230VAC 输入 230VAC input	-	80	-	

## 2.3 一般参数 General parameters

项目 Item	工作条件 conditions	最小值 Min	典型值 Typ	最大值 Max	单位 Unit
隔离电压 Isolation voltage	输入-输出 Input output 测试时间 1 分钟, 漏电流 $\leq 5\text{mA}$ The test time is 1 minute, and the leakage current is $\leq 5\text{mA}$	4000	-	-	VAC
工作温度 Operating Temp	-	-40	-	+70	$^{\circ}\text{C}$
存储温度 Storage Temp	-	-40	-	+85	$^{\circ}\text{C}$
存储湿度 Storage humidity	-	-	-	95	%RH
焊接温度 welding temperature	波峰焊焊接 Wave soldering	260 $\pm$ 5 $^{\circ}\text{C}$ ; 时间: 5-10s 260 $\pm$ 5 $^{\circ}\text{C}$ ; time: 5-10s			
	手工焊接 Manual welding	360 $\pm$ 10 $^{\circ}\text{C}$ ; 时间: 3-5s 360 $\pm$ 10 $^{\circ}\text{C}$ ; time: 3-5s			
开关频率 switching frequency	-	-	65	-	kHz
功率降额 Power derating	-40 $^{\circ}\text{C}$ - -25 $^{\circ}\text{C}$	2.7	-	-	%/ $^{\circ}\text{C}$
	+50 $^{\circ}\text{C}$ - +70 $^{\circ}\text{C}$ 12V 输出 12V Output	2.4	-	-	
	+55 $^{\circ}\text{C}$ - +70 $^{\circ}\text{C}$ 其他 Other	2.7	-	-	
安全标准 safety standards	-	EN60601-1			
安规认证 Safety certification	-	EN60601-1			
安全等级 Safety level	-	CLASSII			
绝缘防护等级 Insulation protection grade	一次侧-二次侧 Primary side- Secondary side	2 $\times$ MOPP			
平均无故障时间 Mean time between failure	25 $^{\circ}\text{C}$	$\geq 300000\text{H}$			

## 2.4 EMC 参数 EMC parameters

	项目 Item	认证 Certification	数值 Data	单位 Unit
EMI	传导骚扰 Conducted disturbance	EN55011(CISPR11)/ EN55032(CISPR32) CLASS B	-	-
	辐射骚扰 Radiation disturbance	EN55011(CISPR11)/ EN55032(CISPR32) CLASS B	-	-
	电压波动 Voltage flicker	EN61000-3-2	-	-
	谐波电流 Harmonic current	EN61000-3-2	-	-
EMS	静电放电 ESD	IEC/EN61000-4-2	±8/Contact ±2、4、8、15/Air	KV
	辐射抗扰度 Radiated immunity	IEC/EN61000-4-3	10	V/m
	脉冲群抗扰度 Burst immunity	IEC/EN61000-4-4	±2	KV
	浪涌抗扰度 Surge immunity	IEC/EN61000-4-5	±0.5/±1 Professional/Family medicine	KV
	传导骚扰抗扰度 Conducted disturbance immunity	IEC/EN61000-4-6	3Vm/0.15MHz-80MHz 6Vm (Within 15m band) /0.15MHz-80MHz 80%AM,1kHz	-
	电压暂降、跌落和短时中断抗扰度 Immunity to voltage sags, sags and short interruptions	IEC/EN61000-4-11	0%UT 0.5cycle 0°, 45°, 90°, 135°, 180°, 270°, 315°。 0%UT 1cycle 70%UT 25/30 cycle 0° 0%UT 250/300 cycle	-

### 3、特性曲线 Characteristic curve

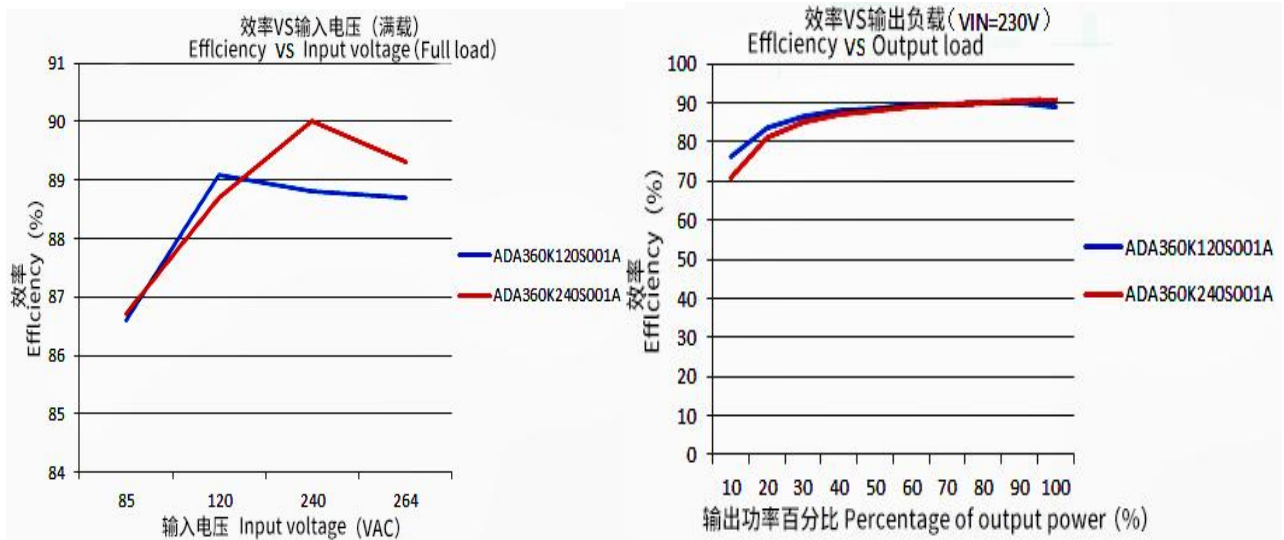

### 4、典型应用电路 Typical application circuit

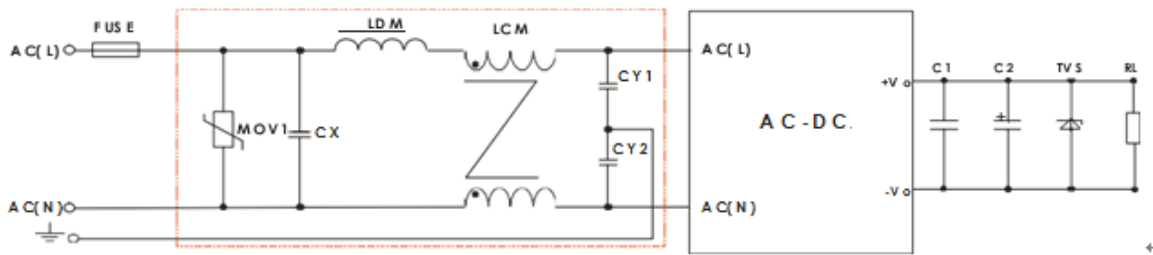

备注：EMC 更高要求无需外加任何电路。

Note: EMC has higher requirements without any additional circuit.

#### Pst and limit line

Pst和限制线

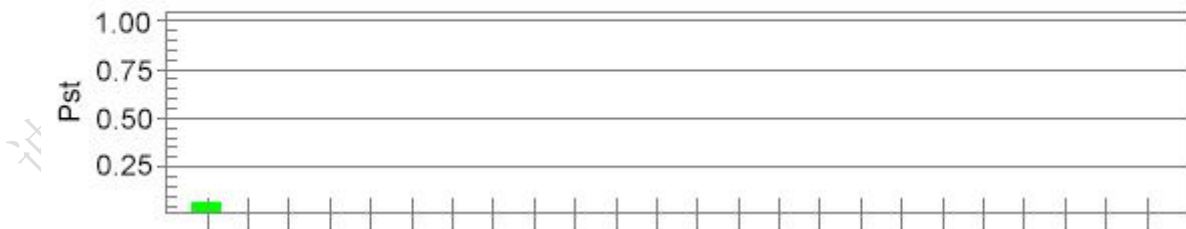

**PIt and limit line**

PIt和限制线

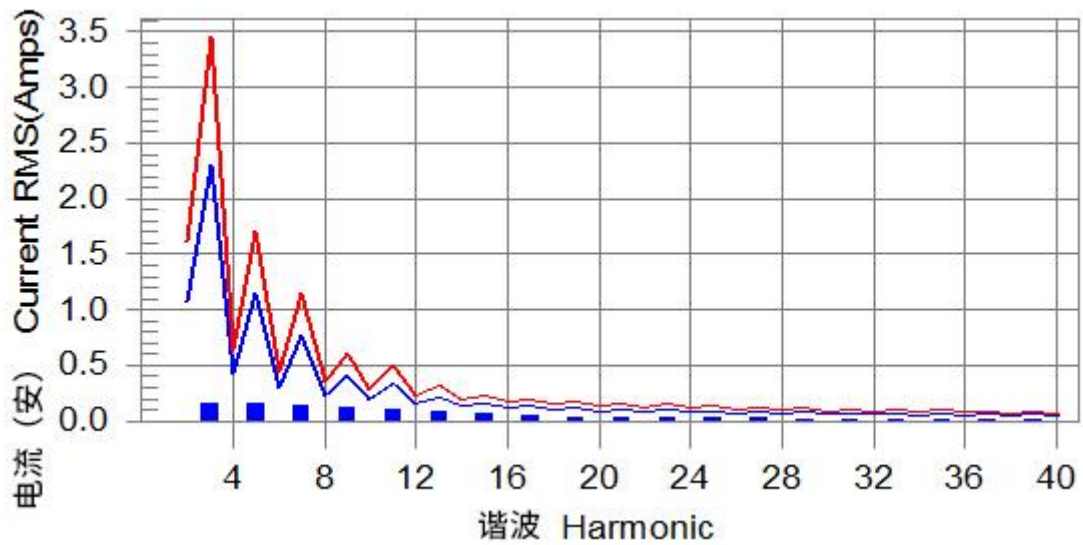
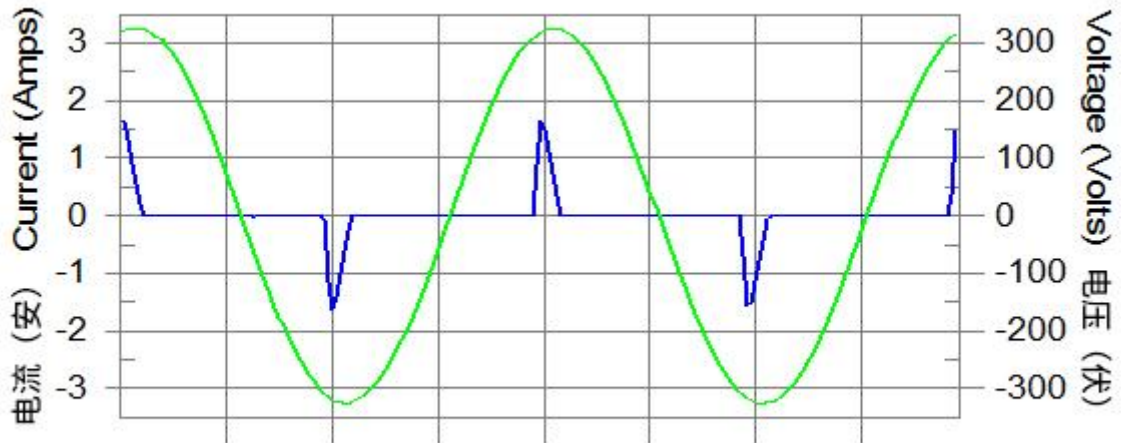
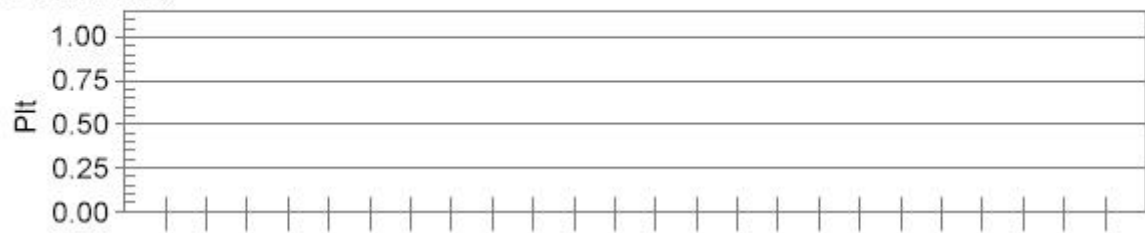



## 5、物理尺寸 Physical Drawing

外形尺寸 Form Factor	70*47*48mm
外壳材料 Shell material	黑色阻燃耐热塑料 (UL94V-0) Black flame retardant and heat resistant plastics (UL94V-0)
冷却方式 Cooling mode	自然空冷 Natural air cooling
电源电缆规格 Power cable specifications	ul2464×22Awg*1m, 5.5*2.5 直头+磁环+SR ul2464 × 22Awg * 1m, 5.5 * 2.5 straight head + magnetic ring + SR

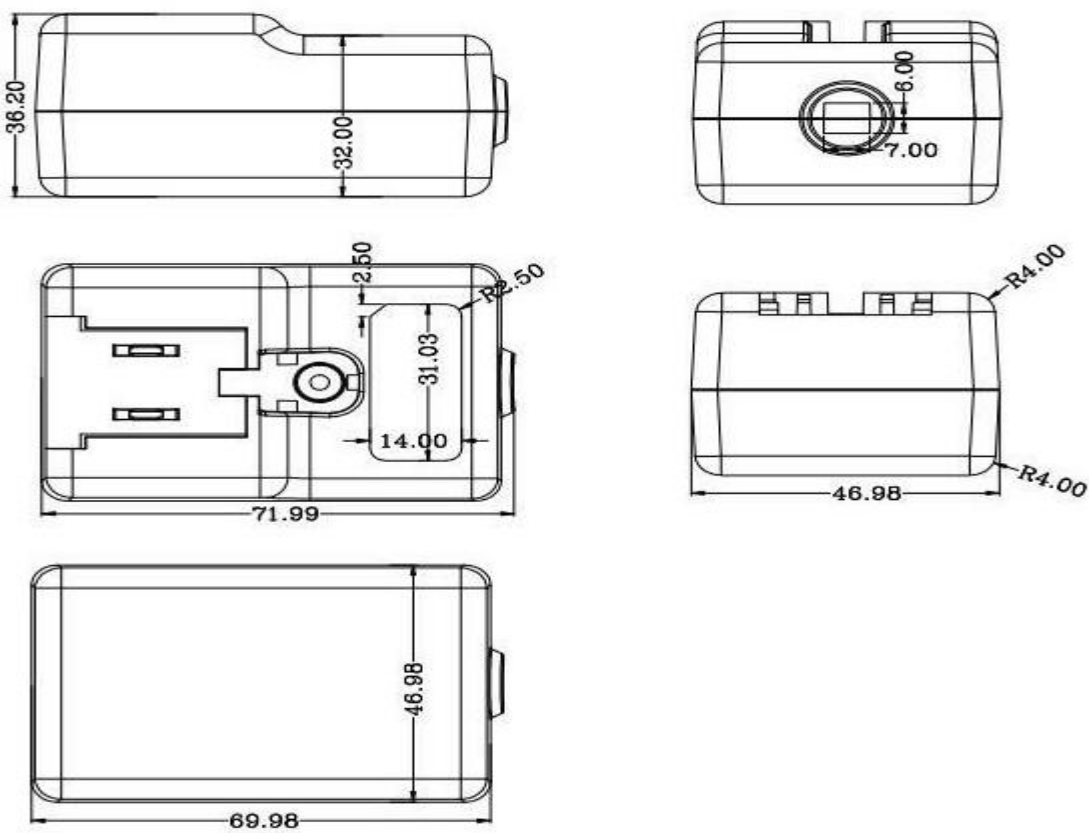

## 6、使用注意事项 Precautions for use

应避免设备与其他设备临近或叠放使用，可能导致操作不当。如果必须临近或叠放使用，应注意观察并校验本设备和其他设备，确保能正常工作。

Avoid using the equipment close to or stacked with other equipment, which may lead to improper operation. If it must be used close to or stacked, pay attention to observe and verify the equipment and other equipment to ensure normal operation.

使用设备制造商指定货提供的其他配件、传感器和电缆可能会引起电磁辐射增加或抗扰度降低。

The use of other accessories, sensors and cables provided by the equipment manufacturer may increase the electromagnetic radiation or reduce the immunity.

便携式射频通信设备离设备的使用距离不应该大于 30cm，否则可能导致设备的性能降低。

The distance between the portable radio frequency communication equipment and the equipment should not be greater than 30cm, otherwise the performance of the equipment may be reduced.

## 7、修订记录 Record of Revision

版本 Rev	日期 Revise Date	描述 Content	编辑人 Editor
00	2021-04-20	首次发布 First Edition	杨泽华
01	2021-05-25	添加命名规则 Add Naming Rules	杨泽华
02	2021-05-27	添加使用注意事项 Add Precautions For Use	杨泽华
03	2021-05-31	添加参数 Add parameters	杨泽华
04	2021-07-15	图片替换 Replace Image	刘 红
05	2022-02-22	升级版本 Upgrade version	刘 红